

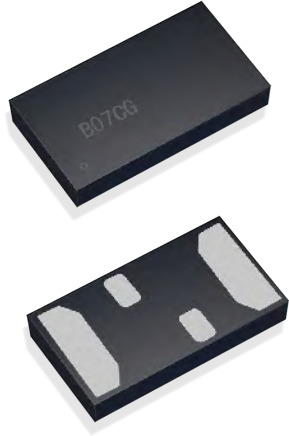

YSO1533MK



Features

- Small SMD package: 2.0 x 1.2 mm (2012)^[1]
- Pin-compatible to 2012 XTAL SMD package
- Fixed 32.768 kHz output frequency
- <20 ppm frequency tolerance
- Ultra-low power: <1 μ A
- Supports coin-cell or super-cap battery backup voltages
- Vdd supply range: 1.5V to 3.63V over -40°C to +85°C
- Oscillator output eliminates external load caps
- Internal filtering eliminates external Vdd bypass cap
- NanoDrive™ programmable output swing for lowest power

Applications

- Mobile Phones, Tablets, Health and Wellness Monitors, Fitness Watches
- Sport Video Cams, Wireless Keypads, Ultra-Small Notebook PC
- Pulse-per-Second (pps) Timekeeping, RTC Reference Clock

Note: 1. For the smallest 32 kHz XO in CSP (1.2mm²), consider the YSO1532MK



Electrical Characteristics

Parameter	Symbol	Min.	Typ.	Max.	Unit	Condition
Frequency and Stability						
Fixed Output Frequency	F _{out}		32.768		kHz	
Frequency Stability						
Frequency Tolerance ^[2]	F _{tol}			20	ppm	T _A = 25°C, post reflow, Vdd: 1.5V – 3.63V.
Frequency Stability ^[3]	F _{stab}			75	ppm	T _A = -10°C to +70°C, Vdd: 1.5V – 3.63V.
				100		T _A = -40°C to +85°C, Vdd: 1.5V – 3.63V.
				250		T _A = -10°C to +70°C, Vdd: 1.2V – 1.5V.
25°C Aging		-1		1	ppm	1st Year
Supply Voltage and Current Consumption						
Operating Supply Voltage	Vdd	1.2		3.63	V	T _A = -10°C to +70°C
		1.5		3.63	V	T _A = -40°C to +85°C
Core Operating Current ^[4]	I _{dd}		0.90		μ A	T _A = 25°C, Vdd: 1.8V. No load
				1.3		T _A = -10°C to +70°C, Vdd max: 3.63V. No load
				1.4		T _A = -40°C to +85°C, Vdd max: 3.63V. No load
Output Stage Operating Current ^[4]	I _{dd_out}		0.065	0.125	μ A/Vpp	T _A = -40°C to +85°C, Vdd: 1.5V – 3.63V. No load
Power-Supply Ramp	t _{Vdd_Ramp}			100	ms	T _A = -40°C to +85°C, 0 to 90% Vdd
Start-up Time at Power-up ^[5]	t _{start}		180	300	ms	T _A = -40°C \leq T _A \leq +50°C, valid output
				450		T _A = +50°C < T _A \leq +85°C, valid output
Operating Temperature Range						
Commercial Temperature	T _{use}	-10		70	°C	
Industrial Temperature		-40		85	°C	

Notes:

- Measured peak-to-peak. Tested with Agilent 53132A frequency counter. Due to the low operating frequency, the gate time must be \geq 100 ms to ensure an accurate frequency measurement.
- Stability is specified for two operating voltage ranges. Stability progressively degrades with supply voltage below 1.5V. Measured peak-to-peak. Inclusive of Initial Tolerance at 25°C, and variations over operating temperature, rated power supply voltage and load.
- Core operating current does not include output driver operating current or load current. To derive total operating current (no load), add core operating current + (0.065 μ A/V) * (peak-to-peak output Voltage swing).
- Measured from the time Vdd reaches 1.5V.



YSO1533MK



Electrical Characteristics (continued)

Parameter	Symbol	Min.	Typ.	Max.	Unit	Condition
LVC MOS Output Option, T_A = -40°C to +85°C, typical values are at T_A = 25°C						
Output Rise/Fall Time	tr, tf		100	200	ns	10-90% (V _{dd}), 15 pF load, V _{dd} = 1.5V to 3.63V
				50		10-90% (V _{dd}), 5 pF load, V _{dd} ≥ 1.62V
Output Clock Duty Cycle	DC	48		52	%	
Output Voltage High	VOH	90%			V	V _{dd} : 1.5V – 3.63V. I _{OH} = -10 μA, 15 pF
Output Voltage Low	VOL			10%	V	V _{dd} : 1.5V – 3.63V. I _{OL} = 10 μA, 15 pF
NanoDrive™ Programmable, Reduced Swing Output						
Output Rise/Fall Time	tf, tr			200	ns	30-70% (V _{OL} /V _{OH}), 10 pF Load
Output Clock Duty Cycle	DC	48		52	%	
AC-coupled Programmable Output Swing	V _{sw}		0.20 to 0.80		V	YSO1533MK does not internally AG-couple. This output description is intended for a receiver that is AC-coupled. See Table 2 for acceptable NanoDrive swing options. V _{dd} : 1.5V – 3.63V, 10 pF Load, I _{OH} / I _{OL} = ±0.2 μA.
DC-Biased Programmable Output Voltage High Range	VOH		0.60 to 1.225		V	V _{dd} : 1.5V – 3.63V. I _{OH} = -0.2 μA, 10 pF Load. See Table 1 for acceptable V _{OH} /V _{OL} setting levels.
DC-Biased Programmable Output Voltage Low Range	VOL		0.35 to 0.80		V	V _{dd} : 1.5V – 3.63V. I _{OL} = 0.2 μA, 10 pF Load. See Table 1 for acceptable V _{OH} /V _{OL} setting levels.
Programmable Output Voltage Swing Tolerance		-0.055		0.055	V	T _A = -40°C to +85°C, V _{dd} = 1.5V to 3.63V.
Period Jitter	T _{jitt}		35		ns _{RMS}	Cycles = 10,000, T _A = 25°C, V _{dd} = 1.5V – 3.63V

Pin Configuration

SMD Pin	Symbol	I/O	Functionality
1	NC	No Connect	No Connect. Will not respond to any input signal. When interfacing to an MCU's XTAL input pins, this pin is typically connected to the receiving IC's X Out pin. In this case, the YSO1533MK will not be affected by the signal on this pin. If not interfacing to an XTAL oscillator, leave pin1 floating (no connect).
2	GND	Power Supply Ground	Connect to ground. All GND pins must be connected to power supply ground.
3	CLK Out	OUT	Oscillator clock output. When interfacing to an MCU's XTAL, the CLK Out is typically connected to the receiving IC's X IN pin. The YSO1533MK oscillator output includes an internal driver. As a result, the output swing and operation is not dependent on capacitive loading. This makes the output much more flexible, layout independent, and robust under changing environmental and manufacturing conditions.
4	Vdd	Power Supply	Connect to power supply 1.5V ≤ V _{dd} ≤ 3.63V for operation over -40°C to +85°C temperature range. Under normal operating conditions, V _{dd} does not require external bypass/decoupling capacitor(s). Internal power supply filtering will reject more than ±150 mVpp with frequency components through 10MHz. Contact factory for applications that require a wider operating supply voltage range.

SMD Package (Top View)

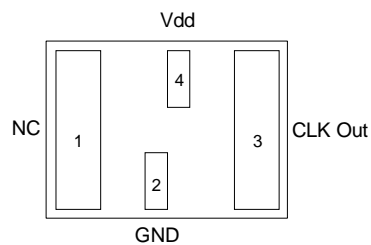



YSO1533MK



Dimensions and Patterns

Package Size – Dimensions (Unit: mm)	Recommended Land Pattern (Unit: mm)
<p>2.0 x 1.2 mm SMD</p>	<p>YXC Only SPL</p> <p>YXC Alternate SPL with Larger Center Pads</p> <p>XTAL Compatible SPL</p>

PART Number Guide

Quartz Crystal Oscillator	Dimensions	Frequency (Hz)	Frequency Stability Overall (ppm)	Output	Pin	Material	Operating Temp. Range
O	2012	32768K	S	D14	4	M	I



YSO1533MK



System Block Diagram

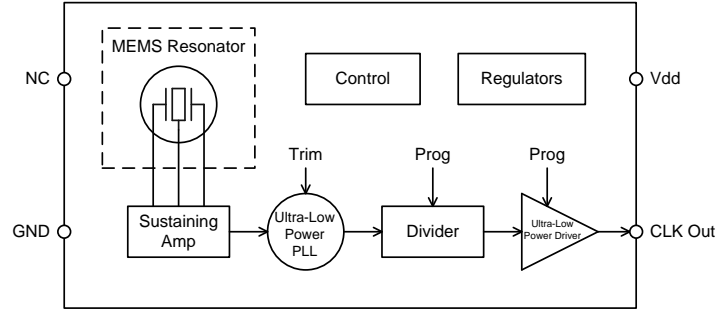

Figure 1.

Absolute Maximum

Attempted operation outside the absolute maximum ratings may cause permanent damage to the part. Actual performance of the IC is only guaranteed within the operational specifications, not at absolute maximum ratings.

Parameter	Test Condition	Value	Unit
Continuous Power Supply Voltage Range (Vdd)		-0.5 to 3.63	V
Short Duration Maximum Power Supply Voltage (Vdd)	≤30 minutes, over -40°C to +85°C	4.0	V
Continuous Maximum Operating Temperature Range	Vdd = 1.5V - 3.63V	105	°C
Short Duration Maximum Operating Temperature Range	Vdd = 1.5V - 3.63V, ≤30 mins	125	°C
Human Body Model ESD Protection	HBM, JESD22-A114	3000	V
Charge-Device Model (CDM) ESD Protection	JESD220C101	750	V
Machine Model (MM) ESD Protection	T _A = 25°C	300	V
Latch-up Tolerance	JESD78 Compliant		
Mechanical Shock Resistance	Mil 883, Method 2002	10,000	g
Mechanical Vibration Resistance	Mil 883, Method 2007	70	g
2012 SMD Junction Temperature		150	°C
Storage Temperature		-65°C to 150°C	



YSO1533MK



XTAL Footprint Compatibility (SMD Package)

The YSO1533MK is a replacement to the 32 kHz XTAL in the 2.0x 1.2 mm (2012) package. Unlike XTAL resonators, YXC's silicon MEMS oscillators require a power supply (Vdd) and ground (GND) pin. Vdd and GND pins are conveniently placed between the two large XTAL pins. When using the YXC Solder Pad Layout (SPL), the YSO1533MK footprint is compatible with existing 32 kHz XTALs in the 2012 SMD package. Figure 2 shows the comparison between the quartz XTAL footprint and the YXC footprint. For applications that require the smallest footprint solution, consider the YSO1532MK XO available in a 1.2mm² CSP.

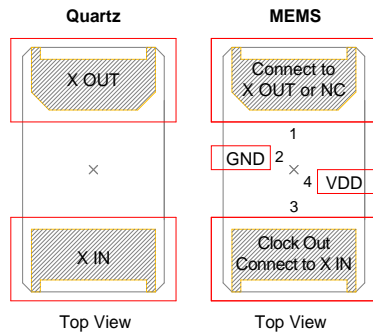

Figure 2. YSO1533MK Footprint Compatibility with Quartz XTAL Footprint [6]

Frequency Stability

The YSO1533MK is factory calibrated (trimmed) to guarantee frequency stability to be less than 20 ppm at room temperature and less than 100 ppm over the full -40°C to +85°C temperature range. Unlike quartz crystals that have a classic tuning fork parabola temperature curve with a 25°C turnover point, the YSO1533MK temperature coefficient is extremely flat across temperature. The device maintains less than 100 ppm frequency stability over the full operating temperature range when the operating voltage is between 1.5 and 3.63V as shown in Figure 3. Functionality is guaranteed over the 1.2V - 3.63V operating supply voltage range. However, frequency stability degrades below 1.5V and steadily degrades as it approaches the 1.2V minimum supply due to the internal regulator limitations. Between 1.2V and 1.5V, the frequency stability is 250 ppm max over temperature. When measuring the YSO1533MK output frequency with a frequency counter, it is important to make sure the counter's gate time is ≥ 100 ms. The slow frequency of a 32 kHz clock will give false readings with faster gate times.

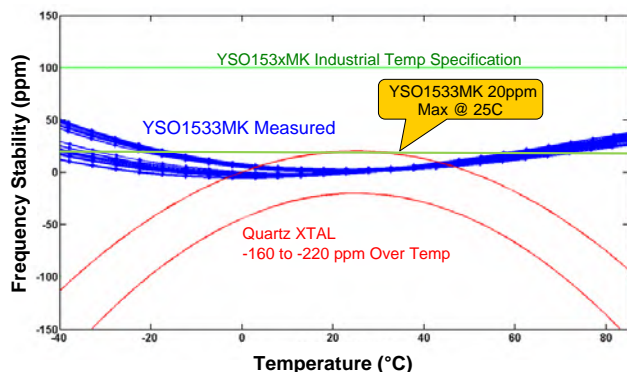

Figure 3. MEMS vs. Quartz

Power Supply Noise Immunity

The YSO1533MK is an ultra-small 32 kHz oscillator. In addition to eliminating external output load capacitors common with standard XTALs, this device includes special power supply filtering and thus, eliminates the need for an external Vdd by pass-decoupling capacitor. This feature further simplifies the design and keeps the footprint as small as possible. Internal power supply filtering is designed to reject AC-noise greater than ± 150 mVpp magnitude and beyond 10 MHz frequency component.

Output Voltage

The YSO1533MK has two output voltage options. One option is a standard LVCMOS output swing. The second option is the NanoDrive reduced swing output. Output swing is customer specific and programmed between 200 mV and 800 mV. For DC-coupled applications, output V_{OH} and V_{OL} are individually factory programmed to the customers' requirement. V_{OH} programming range is between 600 mV and 1.225V in 100 mV increments. Similarly, V_{OL} programming range is between 350 mV and 800 mV. For example; a PMIC or MCU is internally 1.8V logic compatible, and requires a $1.2V_{IH}$ and a $0.6V_{IL}$. Simply select YSO1533MK NanoDrive factory programming code to be "D14" and the correct output thresholds will match the downstream PMIC or MCU input requirements. Interface logic will vary by manufacturer and we recommend that you review the input voltage requirements for the input interface. For DC-biased NanoDrive output configuration, the minimum V_{OL} is limited to 350mV and the maximum allowable swing ($V_{OH} - V_{OL}$) is 750mV. For example, 1.1V V_{OH} and 400mV V_{OL} is acceptable, but 1.2V V_{OH} and 400 mV V_{OL} is not acceptable. When the output is interfacing to an XTAL input that is internally AC-coupled, the YSO1533MK output can be factory programmed to match the input swing requirements.

Power-up

The YSO1533MK starts-up to a valid output frequency within 300 ms (150ms typ). To ensure the device starts-up within the specified limit, make sure the power-supply ramps-up in approximately 10 - 20 ms (to within 90% of Vdd). Start-up time is measured from the time Vdd reaches 1.5V. For applications that operate between 1.2V and 1.5V, the start-up time will be longer.

Note:

6. On the YXC device, X IN is not internally connected and will not respond to any signal. It is acceptable to connect to chipset X OUT.



YSO1533MK



YSO1533MK NanoDrive™

Figure 4 shows a typical YSO1533MK output waveform (into a 10 pF load) when factory programmed for a 0.70V swing and DC bias (V_{OH}/V_{OL}) for 1.8V logic:

Example:

- NanoDrive™ part number coding: D14. Example part number: O201232768KSD144MI
- $V_{OH} = 1.1V$, $V_{OL} = 0.4V$ ($V_{SW} = 0.70V$)

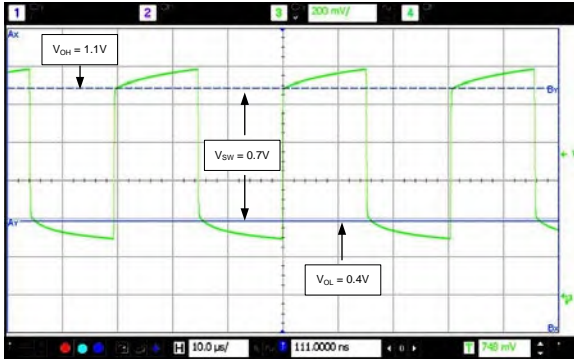

Figure 4. O201232768KSD144MI Output Waveform (10 pF load)

Table 1 shows the supported NanoDrive™ V_{OH} , V_{OL} factory programming options.

Table 1. Acceptable V_{OH}/V_{OL} NanoDrive™ Levels

NanoDrive	V_{OH} (V)	V_{OL} (V)	Swing (mV)	Comments
D26	1.2	0.6	600 ±55	1.8V logic compatible
D14	1.1	0.4	700 ±55	1.8V logic compatible
D74	0.7	0.4	300 ±55	XTAL compatible
AA3	n/a	n/a	300 ±55	XTAL compatible

The values listed in Tables 1 nominal values at 25°C and will exhibit a tolerance of ±55 mV across V_{dd} and -40°C to 85°C operating temperature range.

YSO1533MK Full Swing LVC MOS Output

The YSO1533MK can be factory programmed to generate full - swing LVC MOS levels. Figure 5 shows the typical LVC MOS waveform ($V_{dd} = 1.8V$) at room temperature into a 15 pF load.

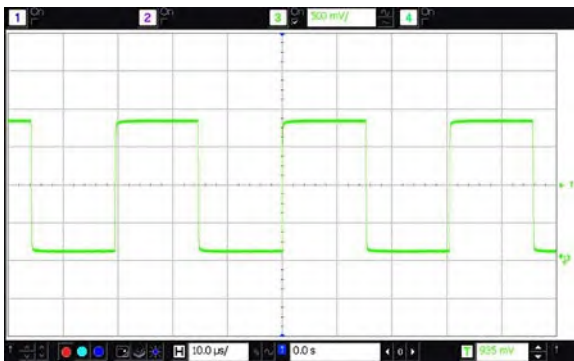

Figure 5. LVC MOS Waveform ($V_{dd} = 1.8V$) into 15 pF Load

Example:

- LVC MOS output part number coding is always **DCC**
- Example part number: O201232768KSDCC4MI

Calculating Load Current

No Load Supply Current

When calculating no-load power for the YSO1533MK, the core and output driver components need to be added. Since the output voltage swing can be programmed for reduced swing between 300 mV and 700 mV, the output driver current is variable. Therefore, no-load operating supply current is broken into two sections; core and output driver. The equation is as follows:

$$\text{Total Supply Current (no load)} = I_{dd \text{ Core}} + (65nA/V)(V_{out_{pp}})$$

Example 1: Full-swing LVC MOS

- $V_{dd} = 1.8V$
- $I_{dd \text{ Core}} = 900nA$ (typ)
- $V_{out_{pp}} = 1.8V$ (LVC MOS)

$$\text{Supply Current} = 900nA + (65nA/V)(1.8V) = 1017nA$$

Example 2: NanoDrive™ Reduced Swing

- $V_{dd} = 1.8V$
- $I_{dd \text{ Core}} = 900nA$ (typ)
- $V_{out_{pp}} (D14) = V_{OH} - V_{OL} = 1.1V - 0.4V = 700mV$

$$\text{Supply Current} = 900nA + (65nA/V)(0.7V) = 946nA$$

Total Supply Current with Load

To calculate the total supply current, including the load, follow the equation listed below. Note the 27% reduction in power with a 1.8V logic compatible NanoDrive™ output voltage.

$$\text{Total Current} = I_{dd \text{ Core}} + I_{dd \text{ Output Driver}} (65nA/V * V_{out_{pp}}) + \text{Load Current} (C * V * F)$$

Example 1: Full-swing LVC MOS

- $V_{dd} = 1.8V$
- $I_{dd \text{ Core}} = 900nA$
- Load Capacitance = 10pF
- $I_{dd \text{ Output Driver}}: (65nA/V)(1.8V) = 117nA$
- Load Current: $(10pF)(1.8V)(32.768kHz) = 590nA$
- Total Current = $900nA + 117nA + 590nA = 1.6\mu A$

Example 2: NanoDrive™ Reduced Swing

- $V_{dd} = 1.8V$
- $I_{dd \text{ Core}} = 900nA$
- Load Capacitance = 10pF
- $V_{out_{pp}} (D14): V_{OH} - V_{OL} = 1.1V - 0.4V = 700mV$
- $I_{dd \text{ Output Driver}}: (65nA/V)(0.7V) = 46nA$
- Load Current: $(10pF)(0.7V)(32.768kHz) = 229nA$
- Total Current = $900nA + 46nA + 229nA = 1.175\mu A$



YSO1533MK



Typical Operating Curves

($T_A = 25^\circ\text{C}$, $V_{dd} = 1.8\text{V}$, unless otherwise stated)

Initial Tolerance Histogram

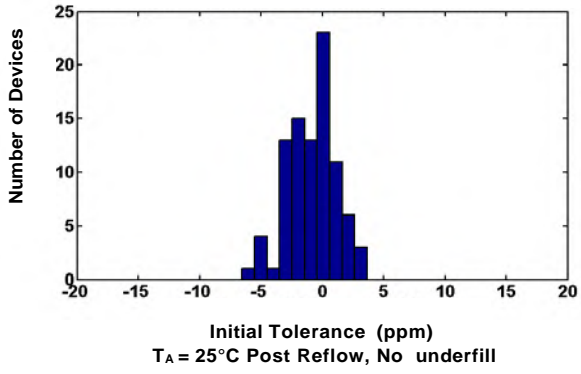

Frequency Stability over Temperature

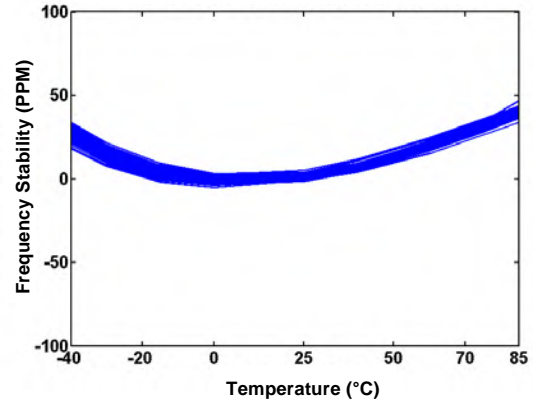

Core Current over Temperature

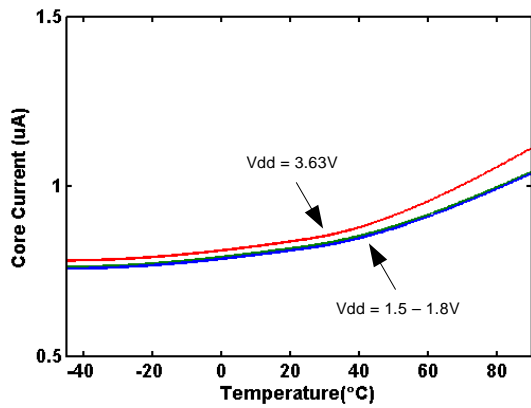

Output Stage Current over Temperature

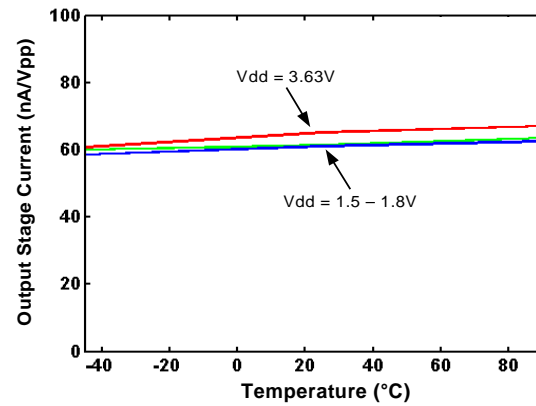

Start-up Time

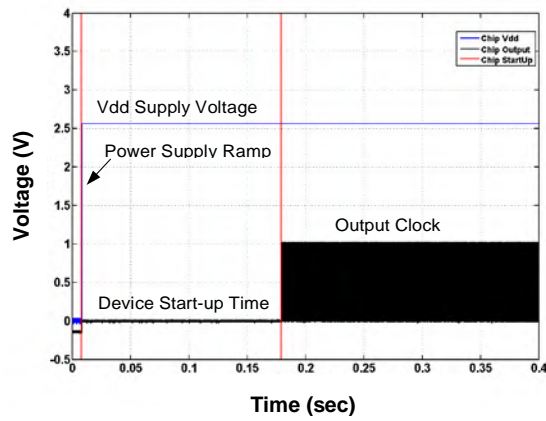



YSO1533MK



Power Supply Noise Rejection (±150mV Noise)

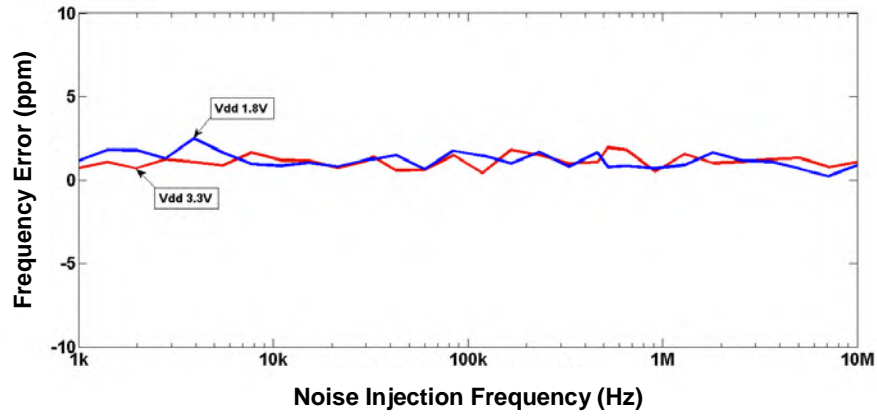

NanoDrive™ Output Waveform ($V_{OH} = 1.1V$, $V_{OL} = 0.4V$; O201232768KSD144MI)

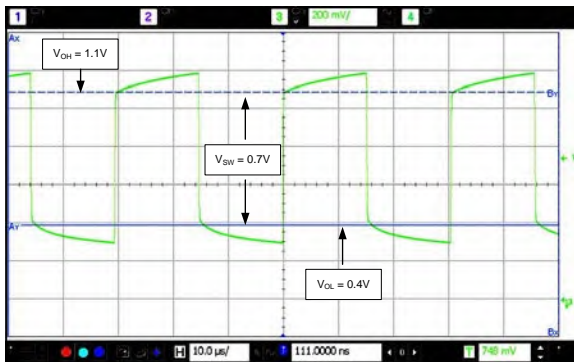

LVC MOS Output Waveform ($V_{swing} = 1.8V$, O201232768KSDCC4MI)

